

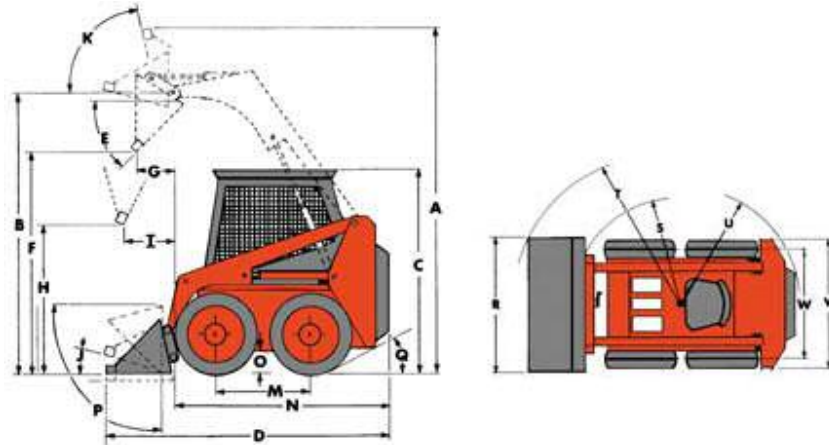

105

1000 lbs (454 kg) Capacity



Dimensional Specifications:	mm
A. Overall Operating Height	3416 mm
B. Height to Hinge Pin	2604 mm
C. Overall Height of Vehicle	1803 mm
D. Overall Length With Bucket	2921 mm
E. Dump Angle	29 °
F. Dump Height	2083 mm
G. Reach - Fully Raised	597 mm
H. Height at 45° Dump Angle	1435 mm
I. Reach at 45° Dump Angle	699 mm
J. Maximum Rollback at Ground	33 °
K. Maximum Rollback - Fully Raised	96 °
M. Wheelbase	843 mm
N. Overall Length - Less Bucket	2311 mm
O. Ground Clearance	178 mm
P. Maximum Grading Angle - Bucket	80 °
Q. Angle of Departure	24 °
R. Bucket Width	1372 mm
S. Clearance Circle Front - Less Bucket	1041 mm

T. Clearance Circle Front - With Bucket	1711 mm
U. Clearance Circle Rear	1372 mm
V. Overall Width - Less Bucket	1289 mm
W. Tread	1016 mm

Note: All dimensions are with rubber tracks and four post canopy