

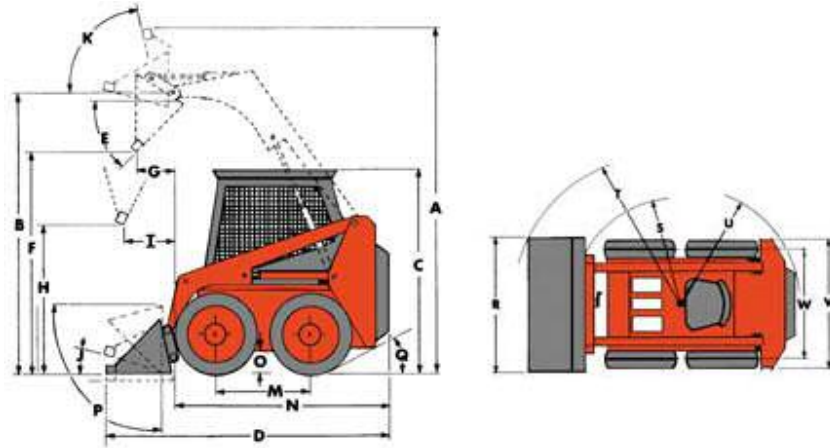

153

1500 lbs (680 kg) Capacity



Dimensional Specifications:	mm
A. Overall Operating Height	3505 mm
B. Height to Hinge Pin	2794 mm
C. Overall Height of Vehicle	1867 mm
D. Overall Length With Bucket	3246 mm
E. Dump Angle	35 °
F. Dump Height	2281 mm
G. Reach - Fully Raised	605 mm
H. Height at 45° Dump Angle	1867 mm
I. Reach at 45° Dump Angle	711 mm
J. Maximum Rollback at Ground	27 °
K. Maximum Rollback - Fully Raised	96 °
M. Wheelbase	889 mm
N. Overall Length - Less Bucket	2652 mm
O. Ground Clearance	191 mm
P. Maximum Grading Angle - Bucket	89 °
Q. Angle of Departure	23 °
R. Bucket Width	1524 mm
S. Clearance Circle Front - Less Bucket	1219 mm

T. Clearance Circle Front - With Bucket	1844 mm
U. Clearance Circle Rear	1572 mm
V. Overall Width - Less Bucket	1461 mm
W. Tread	1184 mm

Note: All dimensions are with rubber tracks and four post canopy