

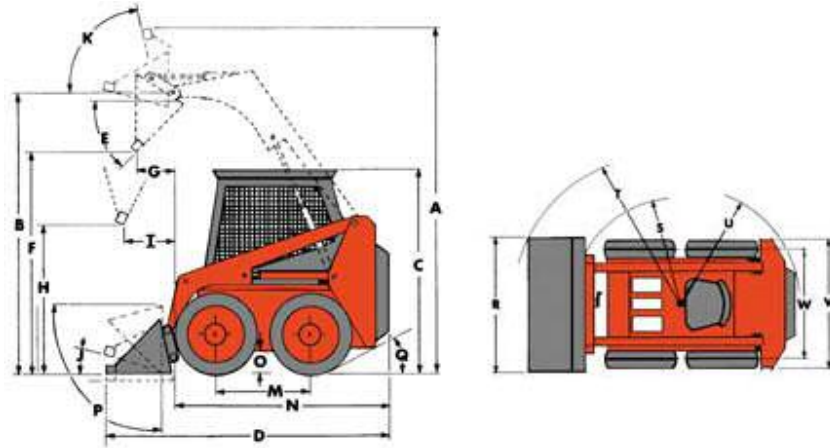

# 85

850 lbs (386 kg) Capacity



Dimensional Specifications:	mm
A. Overall Operating Height	3081 mm
B. Height to Hinge Pin	2375 mm
C. Overall Height of Vehicle	1813 mm
D. Overall Length With Bucket	2673 mm
E. Dump Angle	45 °
F. Dump Height	1753 mm
G. Reach - Fully Raised	368 mm
H. Height at 45° Dump Angle	1753 mm
I. Reach at 45° Dump Angle	368 mm
J. Maximum Rollback at Ground	30 °
K. Maximum Rollback - Fully Raised	95 °
M. Wheelbase	840 mm
N. Overall Length - Less Bucket	2121 mm
O. Ground Clearance	171 mm
P. Maximum Grading Angle - Bucket	93 °
Q. Angle of Departure	30 °
R. Bucket Width	914 mm
S. Clearance Circle Front - Less Bucket	967 mm

T. Clearance Circle Front - With Bucket	1529 mm
U. Clearance Circle Rear	1219 mm
V. Overall Width - Less Bucket	908 mm
W. Tread	743 mm

**Note:** All dimensions are with rubber tracks and four post canopy